



Brosses de surfacage

pour Grande Surfaces Planes



Choisir la brosse

Pièce	Brosse
Bavure 0 à 0.1 mm Acier, Aluminium, plastique	
Bavure 0 à 0.1 mm Aluminium, Acier, Inox	
Bavure 0.1 à 0.2 mm Inox, Titane, Inconel	

La Brosse et le support sont vendus séparément.



Brosses

Diamètre de brosse		Longueur des brins	Réf.	
Ø 125		Rouge	75	B11125
Ø 165			75	B11165
Ø 200			75	B11200
Ø 125		Blanche	75	B21125
Ø 165			75	B21165
Ø 200			75	B21200
Ø 125		Bleue	75	B32125
Ø 165			75	B32165
Ø 200			75	B32200

Supports

pour Brosse	D 2 Ø	Réf.
Ø 125	135	FB1125
Ø 165	176	FB1165
Ø 200	211	FB1200



le Support comprend l'axe d'attachement, le flasque de fixation de la brosse et l'anneau de maintien des brins pendant l'usinage.

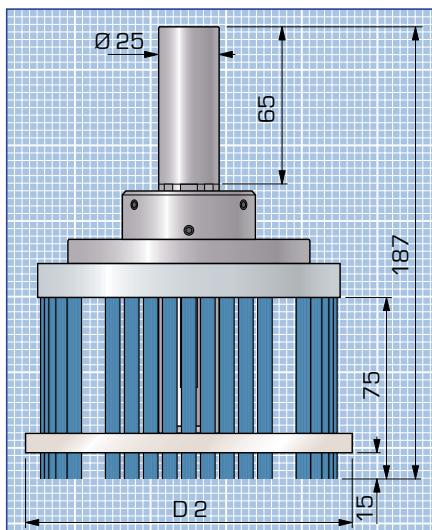

	Pression* mm	Avance mm/min
Ebavurage		
Léger	0.3 à 0.5	4000 - 2500
Standard	0.5 à 1	4000 - 2500
Polissage	0.3 à 0.5	300

* Pression de la brosse par rapport au zéro pièce.

Vitesses de rotation

Brosse	Ø 125	Ø 165	Ø 200
tr/min.	800	600	480

